

# Executive Suites™

## QUALITY CONSTRUCTION SPECIFICATIONS

### **MATERIAL & WORKMANSHIP:**

The specifications contained herein are in compliance with current ANSI/BIFMA Standards for desk products. All exposed hardwoods and veneers are plain-sliced. Veneer matching is "A" quality with no knots, objectionable grain distortion or burrows exhibited. Each veneered surface is flitch matched, using book and slip matching principles. The front modesty panels, pedestals, return panels and cabinets all have vertical grain direction. All wood veneer panels are a balanced multi ply construction with a solid wood core. Tops are hot pressed for added resistance and strength.

### **LAMINATE CABINET OPTION:**

Cabinetry is also available in a thermal fused laminate finish that is highly resistant to scuffs, stains and abrasion. It is available in both wood grain and solid colors (see finish chart). The solid colors can be used in combination with wood veneer drawer and/or door fronts or work surfaces.

### **WIRE MANAGEMENT:**

Removable interior facia covers allow access to wiring and hardware connections. Storage cabinets and risers have power access slots installed in the back when curio and halogen lamps are specified.

### **WORK SURFACES:**

Tops are 1-5/8" thick and are available in a choice hardwood edge detailings. They are field replaceable and can be specified in matching wood veneer or high pressure laminate. Both are applied with a seamless fit with the hardwood edge.

### **PEDESTALS AND LOCKS:**

All cabinets and pedestals are standard in either 18" or 36" widths. They are fully finished on all sides, including the back. The pedestal's vertical walls are of 3/4" thick solid core construction with wood veneer or

thermal fused laminate on all exposed surfaces. All drawer pedestals are field replaceable and/or interchangeable by use of a powered Phillips bit screw driver. All desk file pedestals are equipped with a locking mechanism with a field replaceable locking core. Pedestals are enclosed at the bottom with 3/4" thick dust protector panels.

### **DRAWERS AND FILING:**

All box and file drawers employ EOC's French dovetailed construction using 7/16" thick drawer sides and backs. This provides more storage space (than a 5 sided drawer) and prevents the drawer heads from accidentally coming off. The drawer bottoms are groove fitted into the sides and back and secured on the underside by a hot melt glue. A 7/16" thick 2 1/2" wide wood cross brace reinforces the underside of all box and file drawer bottoms in the main desk pedestals. The top edges of all drawer sides are slightly radiused. The drawer interiors are solid wood with a maple grained finish.

The drawer fronts are of three ply construction. The top and sides of the drawer face are banded in a matching material and finish. All corners and edges are filed and sanded to eliminate sharp corners or snags.

Drawers are standard equipped with metal pulls in a black plated finish. Other drawer pull styles and finishes are available as shown.

All file drawers operate on full ball-bearing progressive heavy duty suspension, captive metal slides. Box drawers are equipped with full suspension captive metal slides. All drawer slides carry a lifetime replacement warranty.

Desk, return and credenza file drawers are equipped with a file folder frame system that adapts for both letter and legal size file folders.

### **CENTER DRAWERS:**

The center drawers are a thin profile design (approximately 2" high) in order to allow for ample knee space under the work surface. They have a special solid hardwood finger grip facia detailing and pencil tray. Center drawers operate on roller action captive metal slides.

### **MODESTY PANELS:**

All modesty panels are 3/4" thick solid wood core three ply construction. The wood veneer or thermal fused laminate grain direction runs vertically. The modesty panel is mounted in such a way so as to be field replaceable with a powered Phillips bit screw driver.

### **CABINETS:**

Wood cabinets have fully finished "A" grade sequence matched veneers on the interior and exterior sides. Laminate cabinets have fully finished interior and exterior sides. All outside backs are finished. The overhead cabinets can be suspended between cabinets of equal height. All base units have adjustable glides for leveling on uneven floor surfaces.

### **WOOD FINISHES:**

EOC's precatalyzed conversion varnish is a multi-step process using the latest technology. It provides advanced stain and mark resistance, easy maintenance and lasting beauty. Stains are hand rubbed (not sprayed) to maximize the wood's beautiful burls and cathedrals. A sealer is applied under all work surfaces to provide a moisture barrier. Veneers and hardwoods are selected, graded, flitch matched and applied to maximize the characteristics and beauty of the natural wood grain. All finishes are in strict compliance with OSHA and AQMD requirements.



Executive Office Concepts • InnerLink • Elements of Care

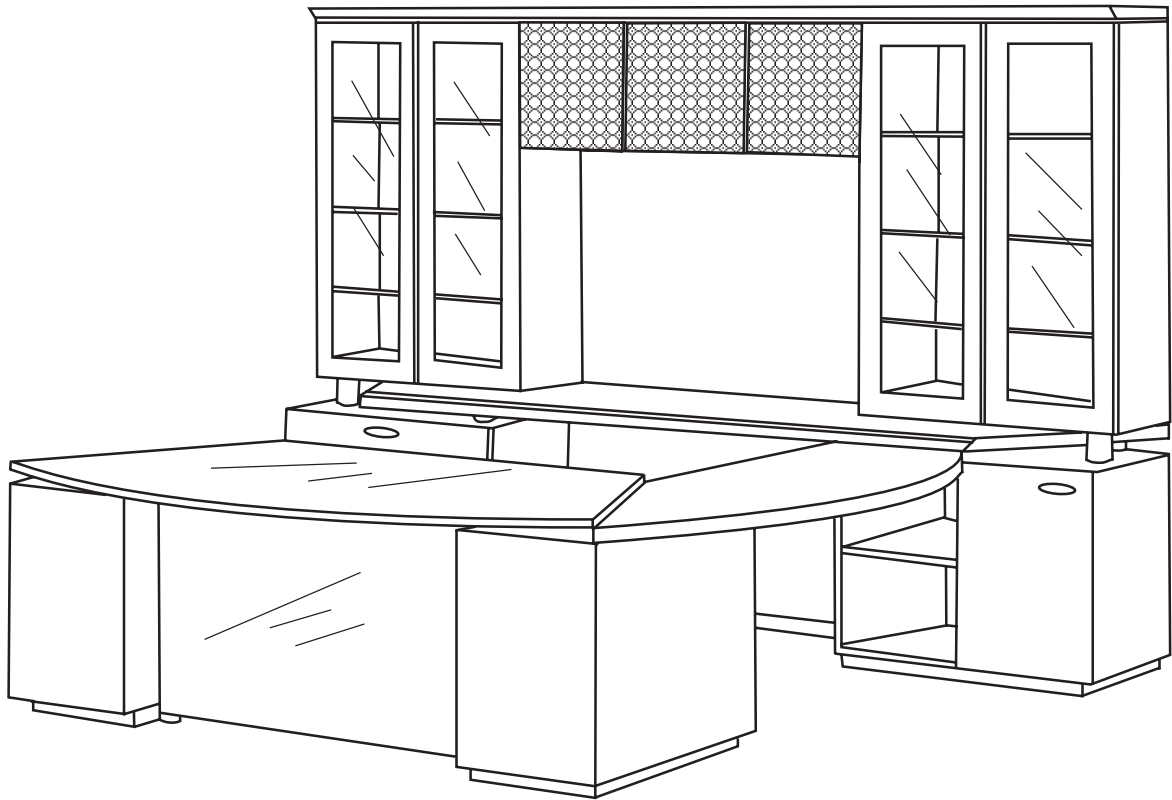

## Executive Suites™

**The Executive Suites** collection takes modular casegoods systems to the next level. It is a complete, fully coordinated desk, seating, conference and reception room furniture collection that is regularly updated with the latest in designer options and accessories.

**Its unique features include** specially shaped floating wood and glass work surfaces on a choice of solid hardwood or polished metal risers. Overhead bridge cabinets freely suspended between storage towers and/or station supports. Fully modular components allow for easy field re-configuration and concealed power passage ways provide for the user's power needs.

**The cast of coordinates** include leather, glass, wood and laminate enhancements that combine to create an endless parade of design options. Executive Suites' main cabinetry and surfaces are engineered on 6" width and depth modules for coordinated planning and installation. Custom sizes and shapes are an important available option.

**Quality construction includes** fully finished cabinet interiors/exterior, French dovetailed wooden drawer sides, reinforced drawer bottoms and lifetime guaranteed full suspension drawer slides.

**Note:** Executive Suites is available on GIZA. See the Seating/Tables price list for matching furniture.

## FINISH AND EDGE DETAIL OPTIONS

The Executive Suites collections are designed to provide a wide choice of finish combinations ranging from transitional to very contemporary. The dual price columns provide for either laminate casework with wood door and drawer fronts ("Lam/Wood"), or wood veneer cabinet construction ("Wood"). In both cases either natural wood veneer, high pressure laminate or plate glass work surfaces can be specified. Wood and laminate surfaces are available with a choice of solid hardwood or self edge details.

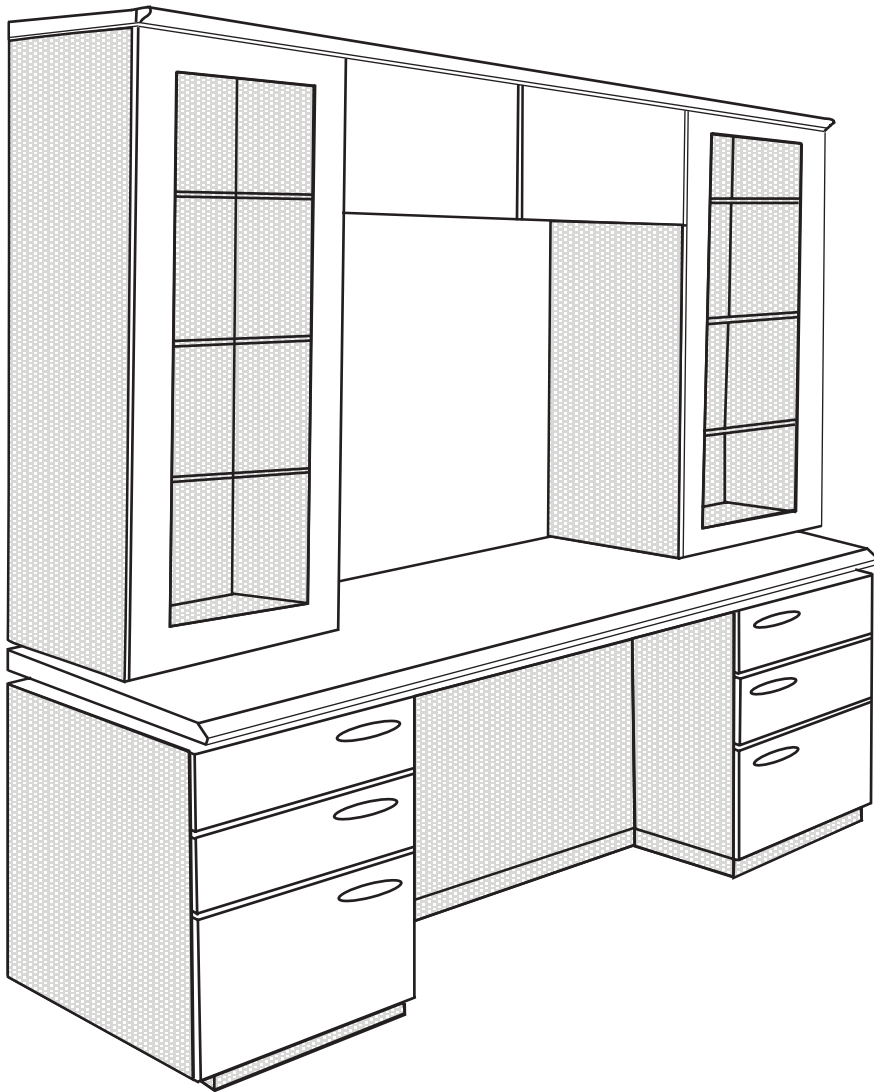

Lam/Wood    Wood



### LAMINATE/WOOD FINISH COMBINATION

EOC's thermal fused laminate cabinetry is very durable and guaranteed against cracking, chipping or delaminating. The standard finish options are a wide choice of solid colors complimentary to the natural wood veneers and hardwoods.

Cabinet shells, panels and bases are available in a choice of solid color laminate cabinet finishes. Doors, drawer fronts and glass door frames are in a choice of wood veneers and hardwoods. Work surfaces are available in either wood veneer or high pressure laminate with a choice of edge detailing. Variations from this pricing theme can be requested. See page 19 for finish options.

### WORK SURFACE HARDWOOD EDGE DETAILS

#### The standard edge detail package:

Main work surfaces have the solid hardwood 2" x 1.5" thick "J" wedge detail on the approach side with the 1.5" wide "V" square edge detail on each end, as well as the back of secondary surfaces. The "J" detail is reversed (for a soft edge) on the occupant side of the main surfaces. The "V" detail is standard on all round, angled, "P" shaped and capsule shaped surfaces. When laminate tops are specified the "E" detail is provided in matching laminate.

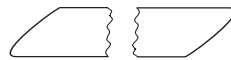

J



E



V

#### The optional "F", "H", "M" or "Y" edge detailing:

These edge detailings are available at no additional charge. They are in solid matching hardwoods and appear on all sides of both the main and secondary work surfaces. These detailings can also be specified on round, angled, "P" shaped and capsule shaped work surfaces. All credenza and wall system backs have the square edge detail.

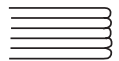

F



H

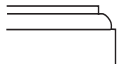

M

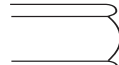

Y

# FINISH AND DRAWER PULL INFORMATION

## WOOD FINISHES:

Except where indicated, conference table tops and bases are available in a choice of Walnut, Cherry and Maple hardwoods and veneers. They are hand sanded, sealed, stained, steel wooled and top coat finished. The following finishes are available in a standard satin finish:

#1 Walnut	13 Mahogany Walnut	18 Cherry Walnut	27 Pearwood
28 Mahogany	33 Natural Maple	40 Natural Cherry	41 Medium Cherry
46 Cranberry	47 Antique Cherry	49 Honey Cherry	100 Chocolate
101 Charcoal			

## FINISH AND WORK SURFACE OPTIONS:

The following is a list of available options and their applicable upcharges.

	Add to Finish #	Extra Charge
<b>LUSTER FINISH:</b> 50 degree luster lacquer finish. Tops are semi-pore filled.	Y	6%
<b>FULL-FILLED LUSTER FINISH:</b> Same as above with a 50 degree full pore filled, hand burnished top.	FY	12%
<b>DECORATIVE TRIM FINISH:</b> Contrasting hardwood moldings in any standard finish.	DT	15%

**NOTICE – GLASS TOPS**

We do not recommend placing glass tops directly on large table surfaces due to the natural undulations and irregularities of wood. Special preparations are required and are subject to extra charges (please inquire).

## DECORATIVE WOOD VENEER INLAYS

The following decorative wood veneers are available as a table surface inlay. To best exhibit their natural beauty these veneers are not stained, unless otherwise specified. They are full filled and polished to a luster finish. Add \$37 list per square foot (rounded) of surface area to the product list price and specify:

#BIY Birds Eye Maple	#FIY Figured Maple	#SIY Sapeli Pommele	#ZIY Zebra Wood
----------------------	--------------------	---------------------	-----------------

## SPECIAL WOOD FINISHES:

EOC will perform custom wood finish work on a project basis providing it falls within our scope and production capabilities. The minimum charge for providing customer finish test panels is \$278 net, which defrays costs for special handling, color chemistry and special finish boards. There may also be a production surcharge, depending on the complexity of the finish and size of order.

## LAMINATE SURFACE FINISHES:

The following laminates are available on table surfaces at no extra charge:

#14 Black	#44 Haze	#48 Fashion Grey	#57 Honey Cherry	#58 Charcoal
#60 Walnut	#61 Victorian Cherry	#63 Natural Maple	#66 Mahogany	#70 Pearwood
#89 Cocoa Leather	#75 White Nebula	#78 Grey Nebula	#87 Camel Leather	#88 Saddle Leather
	#90 Bayou Oxide	#91 Ebony Oxide		

## STONE LAMINATE SURFACE INLAYS:

These premium stone laminates are available as a decorative surface inlay at a 10% surcharge:

#53 Rosso Granite	#79 Black Star Granite	#86 Travertine
#55 Graphite Talc		

## LAMINATE CABINET FINISHES:

The following laminates are available on cabinets and bases where indicated:

#14 Black	#44 Haze	#48 Fashion Grey	#57 Honey Cherry	#58 Charcoal
#17 White	#60 Walnut	#61 Victorian Cherry	#63 Natural Maple	#66 Mahogany
#70 Pearwood				

## DRAWER PULL OPTIONS:

Unless specified otherwise, all furniture will be provided with the standard silver finished die cast #E1 drawer pull. The following pulls are at no additional charge when specified:



**Standard Pull:**  
#E1 Silver

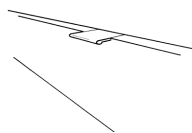

#VP Satin Black

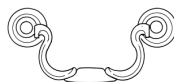

#TB Bright Brass

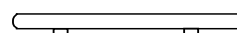

#B1 Silver

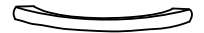

#A1 Satin Chrome

# Metal and Glass Support Elements

Prices shown are for upgrading the standard product with the optional elements listed below.

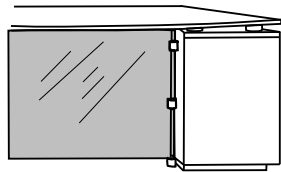

**Floating Glass Modesty Panels.**  
 3/4" thick with polished edges.  
 Includes polished cast aluminum mounting brackets and foot risers.  
 For double and single pedestal style (A & F series) modular desks.

**GM Glass Panel  
 6 Alum. Mounts**

List Price (ea.)	
	893
	759
Total	1652

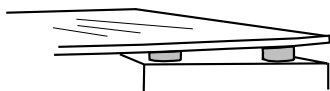

**Polished Metal Risers.**  
 3" diameter solid aluminum risers for floating glass tops (replaces std. wood risers)

**MR**

69

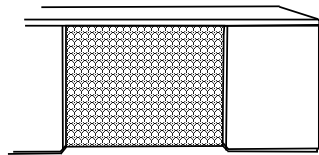

**Metal Front Modesty Panels.**  
 Metal faced desk modesty panel fronts with a perforated (debossed) decorative finish.  
 18 - 36" W  
 37 - 48" W  
 49 - 60" W  
 61 - 72" W  
 73 - 84" W





**MM3  
 MM4  
 MM5  
 MM6  
 MM7**

404  
 540  
 674  
 810  
 944

# Executive Suites™

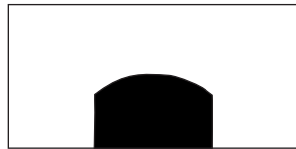
## DECORATIVE SURFACE INLAYS

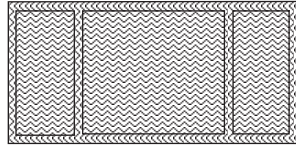
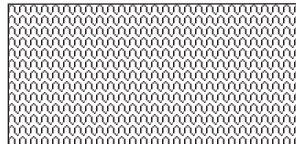
List Prices

Description	Model	Under 72" Long Tops	72"-84" Long Tops	
	<p><b>Center Leather Inlay.</b> Arch shaped center inlay with flush fit stainless steel trim.</p>	LR-1	877	794
	<p><b>Full Leather Inlay.</b> Three sectioned inlay with flush fit stainless steel trim.</p>	LR-2	1757	1588
	<p><b>Full Wood Inlay.</b> Three sectioned veneer inlay with cross banded matching or contrasting wood veneer.</p>	WR-2	401	367
	<p><b>Decorative Veneer Inlay.</b> A choice of the following decorative veneers in a natural (not stained) finish.</p>	<p><b>Birds Eye Maple</b> <b>Sapeli Pommele</b></p>	<p><b>BIY</b> <b>SIY</b></p> <p>695 695</p>	<p>721 721</p>
	<p><b>Center Laminate Inlay.</b> For rear section of credenza or secondary work surface, where power centers may be installed. Includes flush stainless steel trim.</p>	LL-1	621	565

**Note:** The full leather and wood inlays are designed for rectangular or bow shaped work surfaces. Standard leather and laminate inlay colors are black, burgundy, dark green and dark blue.

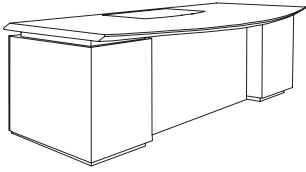

# Executive Suites™

## DOUBLE PEDESTAL DESKS

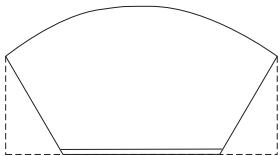
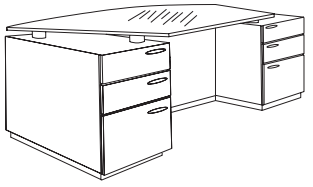
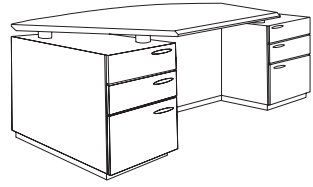
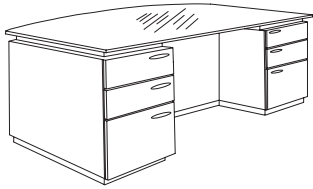

Bow/Wedge Top Detail

Description	Model	Dimensions			List Prices		Wgt.	Cubes
		D	H	W	Lam/Wood	Wood		
<b>Rectangular Top Desk.</b> Wood or laminate top. Two box, 1 file drawer in each pedestal. Recessed front modesty panel.	<b>E66A</b>	30	29	66	4929	5779	355	39
	<b>E72A</b>	36	29	72	5430	6485	365	51
	<b>E78A</b>	36	29	78	5746	6803	376	55
	<b>E84A</b>	36	29	84	5894	6927	386	59
<b>Bow Shaped Top Desk.</b> Wood or laminate top. Two box, 1 file drawer in each pedestal. Recessed front modesty panel.	<b>E172A</b>	42	29	72	5956	7010	377	58
	<b>E178A</b>	42	29	78	6303	7263	387	63
	<b>E184A</b>	42	29	84	6466	7502	397	68
<b>Bow Shaped Top Desk.</b> Beveled plate glass top. Two box, 1 file drawer in each pedestal. Recessed front modesty panel. Finished cylinder risers and pedestal tops.	<b>E272A</b>	42	29	72	7100	8156	442	58
	<b>E278A</b>	42	29	78	7450	8410	457	63
	<b>E284A</b>	42	29	84	7613	8648	473	68
<b>Bow/Wedge Top Desk.</b> Wood or laminate top. Two box, 1 file drawer in each pedestal. Recessed front modesty panel. Finished cylinder risers and pedestal tops.	<b>E384A</b>	48	29	84	7290	7926	393	68
<b>Bow/Wedge Top Desk.</b> Beveled plate glass top. Two box, 1 file drawer in each pedestal. Recessed front modesty panel. Finished cylinder risers and pedestal tops.	<b>E484A</b>	48	29	84	8438	9072	467	68

**For Inlaid leather and decorative veneer tops see page 21.**

**All pedestals are equipped with full locking mechanisms.**

**Drawer and Reference Shelf Options:**

**HD** half drawers (2) in place of one 6" high box drawer. Specify location and add \$225 list.

**RS** retractable shelf and reference drawer. Replaces 6"H box drawer. Add \$187 list.

**CD** hardwood detailed center drawer. Add \$297 list.

**KD** hardwood keyboard drawer. Add \$355 list.

**No charge** to substitute file drawer for two box drawers, or vice versa.

**See page 20 for metal and glass support elements.**

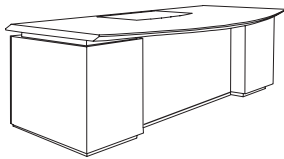

# Executive Suites™

## SINGLE PEDESTAL DESKS

Free Standing and Modular



Description	Model	Dimensions			List Prices		Wgt.	Cubes
		D	H	W	Lam/Wood	Wood		
<b>Rectangular Top Desk.</b> Wood or laminate top. Two box, 1 file drawer in right pedestal. Two shelf tapered storage unit on left. Recessed modesty panel.	<b>E66FL</b>	30	29	66	4347	4910	252	39
	<b>E72FL</b>	36	29	72	4979	5569	289	51
	<b>E78FL</b>	36	29	78	5196	5805	301	55
	<b>E84FL</b>	36	29	84	5385	6013	312	59
		<i>Substitute "R" for "L" for left pedestal desk.</i>						



<b>Bow Shaped Top Desk.</b> Wood or laminate top. Two box, 1 file drawer in right pedestal. Two shelf tapered storage unit on left. Recessed modesty panel.	<b>E172FL</b>	42	29	72	5292	6141	326	59
	<b>E178FL</b>	42	29	78	5695	6363	339	63
	<b>E184FL</b>	42	29	84	5936	6584	352	68
		<i>Substitute "R" for "L" for left pedestal desk.</i>						



<b>Bow Shaped Top Desk.</b> Beveled plate glass top. Two box, 1 file drawer in right pedestal. Two shelf tapered storage unit on left. Recessed modesty panel.	<b>E272FL</b>	42	29	72	6438	7287	379	59
	<b>E278FL</b>	42	29	78	6844	7511	398	63
	<b>E284FL</b>	42	29	84	7084	7731	417	68
		<i>Substitute "R" for "L" for left pedestal desk.</i>						



<b>Bow/Wedge Top Desk.</b> Wood or laminate top. Two box, 1 file drawer in right pedestal. Two shelf tapered storage unit on left. Recessed modesty panel.	<b>E384FL</b>	48	29	84	6381	7008	360	77
	<i>Substitute "R" for "L" for left pedestal desk.</i>							



<b>Bow/Wedge Top Desk.</b> Beveled plate glass top. Two box, 1 file drawer in right pedestal. Two shelf tapered storage unit on left. Recessed modesty panel.	<b>E484FL</b>	48	29	84	7529	8155	434	77
	<i>Substitute "R" for "L" for left pedestal desk.</i>							

**For Inlaid leather and decorative veneer tops see page 21.**

**All pedestals are equipped with full locking mechanisms.**

**Drawer and Reference Shelf Options:**

**HD** half drawers (2) in place of one 6" high box drawer. Specify location and add \$225 list.

**RS** retractable shelf and reference drawer. Replaces 6"H box drawer. Add \$187 list.

**CD** hardwood detailed center drawer. Add \$297 list.

**KD** hardwood keyboard drawer. Add \$355 list.

No charge to substitute file drawer for two box drawers, or vice versa.



**See page 20 for metal and glass support elements.**

# Executive Suites™

These units require a model E15A leg support (page 34) when connecting to glass or wedge top work surfaces.

## MODULAR RETURN UNITS

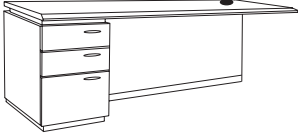
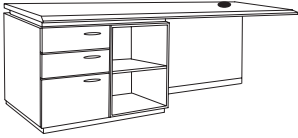
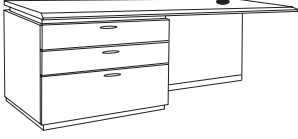
For E and E1 series desks only.

Description	Model	Dimensions			List Prices			
		D	H	W	Lam/Wood	Wood	Wgt.	Cubes
 <p><b>Single Pedestal Return.</b> Two box, 1 file drawer with full height modesty panel and power access.</p>	<b>E48RL</b>	24	29	48	2770	3110	159	17
	<b>E54RL</b>	24	29	54	2917	3258	171	18
	<b>E60RL</b>	24	29	60	2937	3313	182	19
	<b>E66RL</b>	24	29	66	3031	3426	191	20
	<b>E72RL</b>	24	29	72	3118	3532	202	21
<i>For right return, substitute "R" for "L".</i>								
 <p><b>Double Pedestal Return.</b> Two box and 1 file drawer and open media case with roll out printer shelf. Full height modesty panel and power access.</p>	<b>E60RNL</b>	24	29	60	3731	4293	225	26
	<b>E66RNL</b>	24	29	66	3789	4349	234	27
	<b>E72RNL</b>	24	29	72	3875	4456	245	28
<i>For right return, substitute "R" for "L".</i>								
 <p><b>Lateral File Return.</b> 36" wide lateral with 2 box and 1 file drawer. Central locking system. Full height modesty panel and power access.</p>	<b>E60RLFL</b>	24	29	60	3587	3972	204	21
	<b>E66RLFL</b>	24	29	66	3644	4029	213	22
	<b>E72RLFL</b>	24	29	72	3730	4131	224	23
<i>For right return, substitute "R" for "L".</i>								
 <p><b>Storage Cabinet Return.</b> 36" wide swing door cabinet with 1 adjustable shelf. Full height modesty panel and power access.</p>	<b>E60RNDL</b>	24	29	60	3359	3731	179	21
	<b>E66RNDL</b>	24	29	66	3415	3789	188	22
	<b>E72RNDL</b>	24	29	72	3501	3894	199	23
<i>For right return, substitute "R" for "L".</i>								
 <p><b>Triple Pedestal Return.</b> 4 box and 2 file drawers and open media case with roll out printer shelf. Full height modesty panel and power access.</p>	<b>E78RRNL</b>	24	29	78	5520	6339	337	37
	<b>E84RRNL</b>	24	29	84	5586	6406	347	38
	<b>E96RRNL</b>	24	29	96	5772	6628	363	40
<i>For right return, substitute "R" for "L".</i>								

**Drawer, Door and Reference Shelf Options:**

**CD** hardwood detailed center drawer. Add \$297 list.

**KD** hardwood keyboard drawer. Add \$355 list.

**AK** hardwood articulating keyboard shelf. Add \$543 list.





**Two box drawers** can be substituted for any file drawer and vice versa.

**Hinged door** for open media case. Add \$336 list.

**Lock systems are included** on all 36" wide drawer pedestals. Add \$88 list and specify on others.

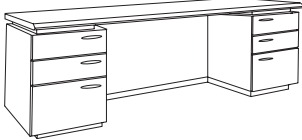
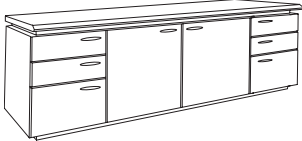
# Executive Suites™

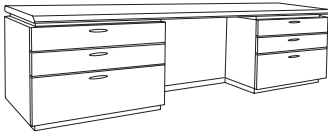
## CREDENZAS

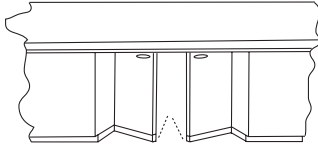
Description	Model	Dimensions			List Prices		Wgt.	Cubes
		D	H	W	Lam/Wood	Wood		
 <p><b>Kneehole Credenza.</b> Two box, 1 file drawer on each side of an open knee hole space. Center modesty panel.</p>	<b>E66RORC</b>	24	29	66	4488	5087	273	32
	<b>E72RORC</b>	24	29	72	4574	5189	284	35
	<b>E78RORC</b>	24	29	78	4744	5377	294	37
 <p><b>Credenza.</b> 2 box, 1 file drawer in each pedestal. Center double swing door bookcase with adjustable shelf.</p>	<b>E72RDRC</b>	24	29	72	6409	7212	364	35
 <p><b>Credenza.</b> Two 36" wide pedestals on each side of an 18"W swing door bookcase with an adjustable center shelf. Total of 4 box and 2 lateral file drawers.</p>	<b>E90RDRC</b>	24	29	90	7180	7873	415	43
 <p><b>Kneehole Credenza.</b> Two 36" wide pedestals on each side of an open knee hole space. Total of 4 box and 2 lateral file drawers. Center modesty panel.</p>	<b>E96RORC</b>	24	29	96	6228	6914	368	46
	<b>E102RORC</b>	24	29	102	6382	7068	378	49
	<b>E108RORC</b>	24	29	108	6420	7125	388	51
 <p><b>Credenza.</b> Two 36" wide pedestals on each side of a 36"W swing door bookcase with an adjustable center shelf. Total of 4 box and 2 lateral file drawers.</p>	<b>E108RDRC</b>	24	29	108	8255	9147	468	51
 <p><b>Wall Access Panel.</b> Two 18" swing doors in the knee hole for wall access. Includes pulls, adjustable hinges, filler panels and 6" deep power collection framework.</p>	<b>WP36</b>	6	27	36	524	751	39	5
	<b>WP42</b>	6	27	42	600	863	41	6
	<b>WP48</b>	6	27	48	676	975	43	7
	<b>WP54</b>	6	27	54	752	1085	45	8
	<b>WP60</b>	6	27	60	829	1199	47	8

**KD** hardwood keyboard drawer. Add \$390 list.





**AK** hardwood articulating keyboard shelf. Add \$543 list.

**Two box drawers** can be substituted for any file drawer and vice versa.

**Lock systems are included** on all 36" wide drawer pedestals. Add \$88 list and specify on others.

# Executive Suites™

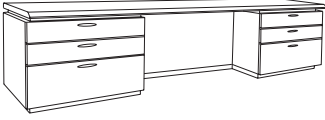
## CREDENZAS

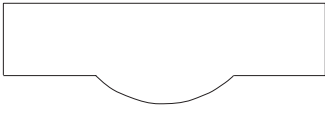
Description	Model	Dimensions			List Prices		Wgt.	Cubes
		D	H	W	Lam/Wood	Wood		
 <p><b>108" Kneehole Credenza.</b> 4 box, 4 file drawers with an 18" wide media cabinet and a 36" wide open knee hole space.</p>	<b>E108SODC</b>	24	29	108	7504	8365	426	51
<p><b>Bow Front Credenza Top Wall Access Panel</b></p>	<b>-BF WP36</b>	<b>Add</b>		<b>Add</b>	903 524	903 751	5 39	1 5
 <p><b>108" Credenza.</b> 4 box, 4 file drawers with both 36" and 18" wide media cabinets w/adjustable shelves.</p>	<b>E108SDRC</b>	24	29	108	9617	10770	490	51
 <p><b>132" Open Credenza.</b> Two 36" wide peds on each side of a 60" wide kneehole space with full ht. modesty. Four 36" wide box and two lateral file drawers. Suitable for wing unit connections.</p>	<b>E132R0RC</b>	24	29	132	7170	7928	463	62
 <p><b>144" Credenza.</b> Four 36" wide dbl. box and lateral file pedestals. 24 cubic feet of storage capacity.</p>	<b>E144RRRRC</b>	24	29	144	11910	13116	695	68
 <p><b>Bow Front Credenza Top.</b> Adds a 36" wide 6" deep arch to the center knee hole space of a credenza or work surface. Includes a curved hardwood edge detail.</p>	<b>-BF</b>	24/30	29		903	903	5	0.5

**KD** hardwood keyboard drawer. Add \$390 list and specify.

**AK** hardwood articulating keyboard shelf. Add \$543 list.

**Two box drawers** can be substituted for any file drawer and vice versa.

**Lock systems are included** on all 36" wide drawer pedestals. Add \$88 list and specify on others.

# Executive Suites™

## 78" HIGH CREDENZA EXAMPLES

Line drawings illustrate grid patterned glass door credenza options.

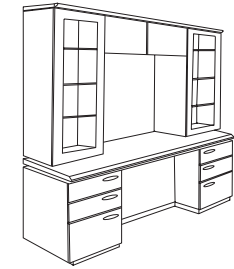

Description	Model	Dimensions			List Prices		Wgt. Cubes	
		D	H	W	Lam/Wood	Wood		
<b>Kneehole Credenza.</b> Two box, 1 file drawer on each side of an open knee hole space. Two 18" wide tower cabinets with bridge.	<b>E72RORDC</b>	24	78	72	9161	10938	526	60
	<b>E90RORDC</b>	24	78	90	9892	11790	554	69
<b>Same</b> w/grid patterned glass doors on towers (as shown).	<b>E72RORGC</b>	24	78	72	10447	12257	526	60
	<b>E90RORGC</b>	24	78	90	11179	13020	554	69



<b>Credenza Station.</b> 2 box, 1 file drawer on each side of a swing dr. cabinet. 2-36"W dbl. door tower storage cabinets.	<b>E72RDRDC</b>	24	78	72	11354	12861	620	78
	<b>E72RDRGC</b>	24	78	72	13825	15306	620	78



<b>Credenza Station.</b> Two 36"W 2 box 1 file peds on each side of an open knee hole space. 2-36"W tower cabinets with 36" bridge.	<b>E108RORDC</b>	24	78	108	12416	14282	706	107
	<b>E108RORGC</b>	24	78	108	14889	16789	706	107



<b>Credenza Station.</b> Two 36"W 2 box 1 file peds on ea side of a swing door cabinet. 2-36"W tower cabinets with 36" bridge.	<b>E108RDRDC</b>	24	78	108	14251	16306	786	107
	<b>E108RDRGC</b>	24	78	108	16725	18811	786	107

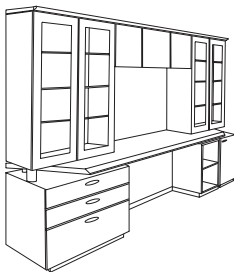

<b>Credenza Station.</b> 2 box, 1 file w/18"W swing dr. & open roll out shelf cabs. 126" wedge top. 2 36"W towers w/54" bridge.	<b>E126RMDDC</b>	24	78	126	13393	15356	795	152
	<b>E126RMGDC</b>	24	78	126	15866	17861	795	152

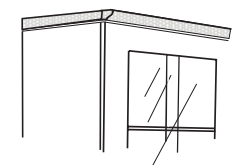

TR Tower Roof Trim

**BF** bow front top at credenza kneehole space. Add \$860 list.  
**WP** Dbl. swing door wall access panel. Sizes and prices on page 25.  
**Two box drawers** can be substituted for any file drawer and vice versa.  
**systems are included** on all 36" wide drawer pedestals. Add \$88 list and specify on others.  
**Lighting, power and keyboard** drawer options are listed in the accessory section.  
**TR tower roof trim** with matching detailed edge. Add \$451 list per cabinet and specify detail.  
**For optional lighting accessories see page 13.**

# Executive Suites™

## 78" HIGH WORK STATION EXAMPLES

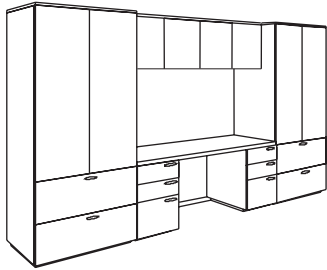

Description	Model	Dimensions			List Prices		Wgt. Cubes	
		D	H	W	Lam/Wood	Wood		
<b>78" x 144" Wall Station.</b> Two 24" deep 36" wide dbl. door cabinets with 2 adj. & 2 fixed shelves and 2 lateral file drawers below. 72" wide overhead swing door unit. 24" x 72" work surface with two 2 box/file pedestals.	<b>E144MRRMC</b>	24	78	144	15600	18400	925	133.5
<b>Same</b> w/grid patterned glass doors on towers (2).	<b>E144GRRGC</b>	24	78	144	18580	20651	911	133.5
<b>78" x 180" Work Station.</b> Two 36"W dbl. dr. cabinets for wardrobe & storage. 2 36"W lateral dwrs. two 2 box & file peds. 108" wall mounted overhead cabinet. 24" x 108" & 36" x 72" capsule work surfaces.	<b>E180MRPWL</b> Capsule Top	24 36	78 29	180 72	18999	21919	1151	173.7
	For reverse layout (right return) substitute letter "R" for "L".							

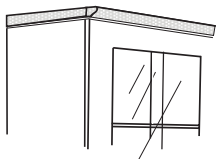
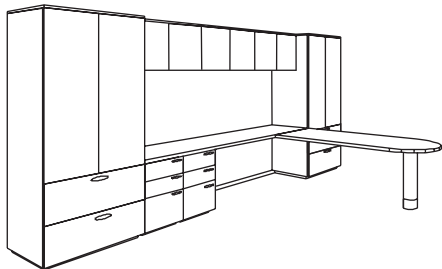

**TR Tower Roof Trim**

See Accessories for lighting, power distribution, tack panels, locks and organizers.  
 See information on detailed tower top trim and decorative wood veneer inlaid worksurfaces.  
**TR tower roof trim** with matching detailed edge. Add \$451 list per cabinet and specify detail.  
**Drawer and Reference Shelf Options:**  
**HD** half drawers (2) in place of one 6" high box drawer. Specify location and add \$231 list.  
**RS** retractable shelf and reference drawer. Replaces 6"H box drawer. Add \$187 list.  
**CD** hardwood detailed center drawer. Add \$297 list.  
**KD** hardwood keyboard drawer. Add \$355 list.  
 No charge to substitute file drawer for two box drawers, or vice versa.

# Executive Suites™

## 78" HIGH WORK STATION EXAMPLES

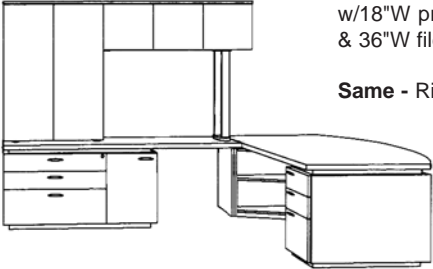
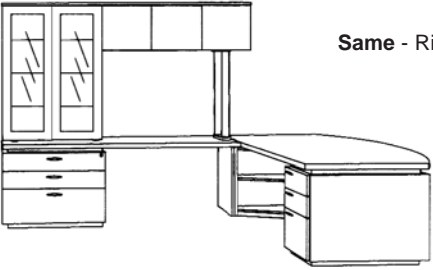
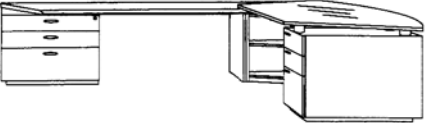
Description	Model	Dimensions			List Prices		Wgt. Cubes	
		D	H	W	Lam/Wood	Wood		
 <p><b>78"H x 126" Work Station.</b> 17 cubic feet of overhead storage space. 36"D desk ped. w/84" x 42" bow top &amp; 2 shelf bkcase. 24" x 84" return w/18"W printer/storage cab. &amp; 36"W file w/2-6"H dwrs.</p> <p><b>Same - Right return.</b></p>	<b>E126MDNFL</b>	84	78	126	15172	17140	847	145
<p><b>Same - Right return.</b></p>	<b>E126MDNFR</b>							
 <p><b>78"H x 126" Work Station.</b> Same as above only with glass dr. 36"W showcase and w/o 18" printer/storage cabinet.</p> <p><b>Same - Right return.</b></p>	<b>E126MGFL</b>	84	78	126	15215	17107	793	138
<p><b>Same - Right return.</b></p>	<b>E126MGFR</b>							
 <p><b>84" x 132" Work Station.</b> 48" x 84" glass bow/wedge shaped top w/24" x 84" wedge shaped (24" x 120" overall) side return. 36"D desk &amp; storage peds. 36"W lateral file w/2 6"H drawers.</p> <p><b>Same - Right return.</b></p>	<b>E484F84LL</b>	84	29	132	11180	12108	612	86
<p><b>Same - Right return.</b></p>	<b>E484F84LR</b>							

**HD** half drawers (2) in place of one 6" high box drawer. Specify location and add \$225 list.

**CD** hardwood detailed center drawer. Add \$297 list.

**RS** retractable shelf and reference drawer. Replaces 6"H box drawer. Add \$187 list.

**KD** hardwood keyboard drawer. Add \$355 list and specify.

**AK** hardwood articulating keyboard shelf. Add \$543 list.

**Two box drawers** can be substituted for any file drawer and vice versa.

**For inlaid leather and decorative veneer tops see page 21.**

**TR tower roof trim** with matching detailed edge. Add \$451 list per cabinet and specify detail.

# Executive Suites™

## “U” UNIT STATION EXAMPLES

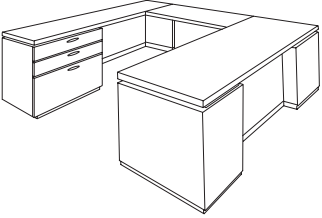
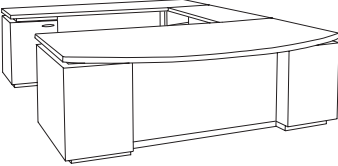
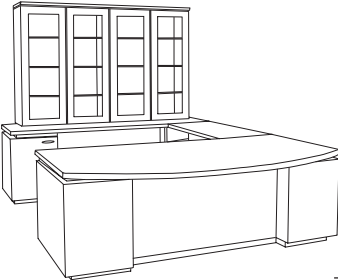
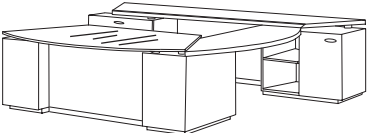
Description	Model	Dimensions			List Prices		Wgt.	Cubes
		D	H	W	Lam/Wood	Wood		
 <p><b>Rectangular U Unit.</b> Wood or laminate tops. 2 box 1 file &amp; shelf unit in either 36" x 72", 78" or 84" desk with 2 box 1 file 36" wide ped. in credenza.</p>	<b>E72UL</b>	108	29	72	9843	11091	590	146
	<b>E78UL</b>	108	29	78	10231	11515	610	158
	<b>E84UL</b>	108	29	84	10457	11777	633	170
	<b>Return</b>	24	29	48				
<b>Same - Right return.</b>	<b>Substitute R for L</b>							
 <p><b>Bow Top U Unit.</b> Wood or laminate tops. 2 box 1 file in desk. 48"L return, swing door cabinet w/adjustable shelf unit in credenza.</p>	<b>E184UL</b>				9959	11103	616	131
	<b>Desk</b>	42	29	84				
	<b>Return</b>	24	29	48				
	<b>Credenza</b>	24	29	84				
	<b>Total</b>	114	29	84				
<b>Same - Right return.</b>	<b>E184UR</b>							
 <p><b>Bow Top U Unit.</b> Wood or laminate tops. 2 box 1 file in desk. 48"L return, 2 glass 1 wood door cabinet w/adjustable shelf unit in credenza.</p>	<b>E184UTGL</b>				17380	19255	855	193
	<b>Desk</b>	42	29	84				
	<b>Return</b>	24	27	48				
	<b>Credenza</b>	24	78	84				
	<b>Total</b>	114	78	84				
	<b>Same - Right return.</b>	<b>E184UTGR</b>						
<p><b>Halogen Lamps (4) - installed.</b></p>	<b>2-2HL</b>				805	805		
 <p><b>Bow/Wedge Top U Unit.</b> Beveled plate glass top. 2 box 1 file in desk. Arched left rtn. 2 box 1 file, swing door cabinet &amp; roll out shelf unit in credenza.</p>	<b>E4126UL</b>				15636	17150	938	141
	<b>Desk</b>	48	29	84				
	<b>Return</b>	16/38	27	51				
	<b>Credenza</b>	24	29	126				
	<b>Total</b>	123	29	126				
<b>Same - Right return.</b>	<b>E4126UR</b>							

All main desks are equipped with a sloped double shelf storage unit on the return side.

For Inlaid leather and decorative veneer tops see page 21.

HD half drawers (2) in place of one 6" high box drawer. Specify location and add \$205 list.

RS retractable shelf and reference drawer. Replaces 6"H box drawer. Add \$187 list.

CD hardwood detailed center drawer. Add \$297 list.

AK hardwood articulating keyboard shelf. Add \$543 list.

KD hardwood keyboard drawer. Add \$355 list.

# Executive Suites™

## “U” UNIT STATION EXAMPLES

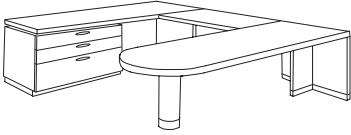
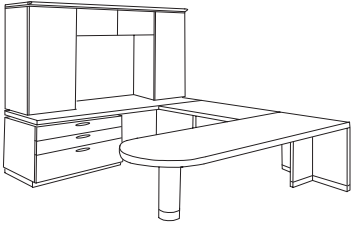
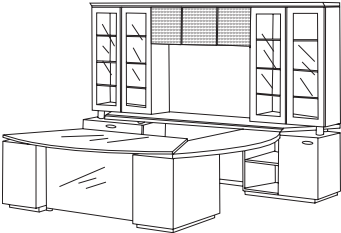
Description	Model	Dimensions			List Prices		Wgt.	Cubes
		D	H	W	Lam/Wood	Wood		
 <p><b>Capsule Top U Unit.</b> Wood or laminate tops. Left return w/36" wide 2 box 1 file ped. In back unit. 6" dia. wood cylinder base.</p>	<b>E72UBL</b>				8263	9425	432	48
	<b>Desk</b>	36	29	72				
	<b>Return</b>	24	29	48				
	<b>Credenza</b>	24	29	72				
	<b>Total</b>	108	29	72				
<b>Same - Right return.</b>	<b>E72UBR</b>							
 <p><b>Capsule Top U Station.</b> Wood or laminate tops. Two 18"W tower cabinets w/36" bridge on back or side unit. 2 box 1file ped. &amp; modesty in back unit. 6" dia. wood cylinder base.</p>	<b>E72URDL</b>				12849	15174	684	80
	<b>Desk</b>	36	29	72				
	<b>Return</b>	24	29	48				
	<b>Credenza</b>	24	78	72				
	<b>Total</b>	108	78	72				
<b>Same - Right return.</b>	<b>E72URDR</b>							
 <p><b>Bow/Wedge Top U Unit.</b> Beveled plate glass top with matching glass modesty panel. Polished metal risers. 2 box 1 file in desk. Arched left rtn. 2 box 1 file, 2 glass door &amp; 2 wood cabinets with roll-out shelf unit in credenza. 3 swing door overhead cabinet with metal debossed fronts.</p>	<b>E126UTGL</b>				27018	30982	1408	233
	<b>Desk</b>	48	29	84				
	<b>Return</b>	16/38	27	51				
	<b>Credenza</b>	24	78	126				
	<b>Total</b>	123	78	126				
<b>Same - Right return.</b>	<b>E126UTGR</b>							
<b>Halogen Lamps (4) - installed.</b>	<b>2-2HL</b>				805	805		

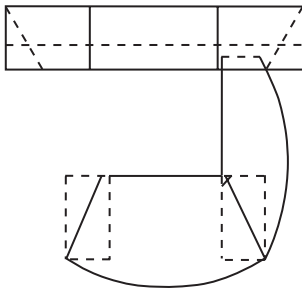

**All main desks are equipped with a sloped double shelf storage unit on the return side. For Inlaid leather and decorative veneer tops see page 21.**

**HD** half drawers (2) in place of one 6" high box drawer. Specify location and add \$225 list.

**RS** retractable shelf and reference drawer. Replaces 6"H box drawer. Add \$187 list.

**CD** hardwood detailed center drawer. Add \$297 list.

**AK** hardwood articulating keyboard shelf. Add \$543 list.

**KD** hardwood keyboard drawer. Add \$355 list.





**TR** tower roof trim with matching detailed edge. Add \$451 list per cabinet and specify detail.

# Executive Suites™

## PEDESTALS

### PEDESTAL PRICES INCLUDE:

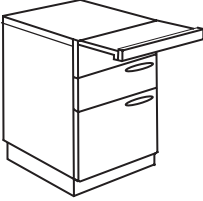
- \* Full Ball-Bearing Progressive Suspension Drawer Slides
- \* Combination Letter/Legal Size Filing
- \* File Drawer Adjustable Folder Frames
- \* Finished Tops and Mitered Backs
- \* Drawers with Central Locking Mechanism

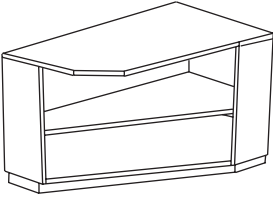
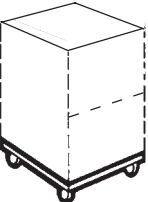
Description	Model	Dimensions			List Prices			
		D	H	W	Lam/Wood	Wood	Wgt.	Cubes
 <p><b>Two Box and File Drawer Pedestal.</b> Includes locking system, mitered corners and finished top.</p> <p>For <b>4 box drawers</b> instead of file drawer, substitute "W" for "R" in model number. Same price.</p>	<b>E24RPL</b>	23.5	26	18	1618	1874	94	9
	<b>E30RPL</b>	29.5	26	18	1812	2065	99	11
	<b>E36RPL</b>	35.5	26	18	2007	2256	104	14
 <p><b>Three Box and File Drawer Pedestal.</b> Includes two 3"H, one 6"H and one 12"H drawer with file folder frame. Includes locking system, mitered corners and finished top.</p>	<b>E24HPL</b>	23.5	26	18	1842	2101	106	9
	<b>E30HPL</b>	29.5	26	18	2039	2292	112	11
	<b>E36HPL</b>	35.5	26	18	2234	2481	118	14
 <p><b>Two Box and File Drawer Pedestal with Reference Shelf.</b> Solid wood shelf, 4"H, 6"H and 12"H drawers all on metal slides with matching fronts. Includes locking system, mitered corners and finished top.</p>	<b>E24EPL</b>	23.5	26	18	1802	2061	109	9
	<b>E30EPL</b>	29.5	26	18	1999	2251	115	11
	<b>E36EPL</b>	35.5	26	18	2193	2442	121	14
 <p><b>Two File Drawer Pedestal.</b> Includes locking system, file folder frames, mitered corners and finished top.</p>	<b>E24SPL</b>	23.5	26	18	1618	1874	90	9
	<b>E30SPL</b>	29.5	26	18	1812	2065	95	11
	<b>E36SPL</b>	35.5	26	18	2007	2256	100	14
 <p><b>Tapered Shelf Pedestal.</b> Replaces panel end on single pedestal and modular desks. Two fixed tapered shelves (5" to 17" depth). Taper provides leg room for return. For right side substitute "R" for "L".</p>	<b>E24GL</b>	23.5	26	6/18	841	1054	54	8
	<b>E30GL</b>	29.5	26	6/18	969	1197	58	10
	<b>E36GL</b>	35.5	26	6/18	1097	1339	62	13
 <p><b>Caster Base.</b> Provides mobility to free standing pedestals via factory installed twin wheel caster base assembly. Adds 1" to pedestal height.</p>	<b>-EC</b>				127	127	6	1



# Executive Suites™

## PEDESTALS and CABINETS

### PEDESTAL PRICES INCLUDE:

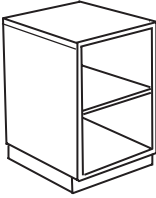
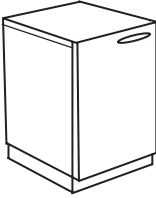
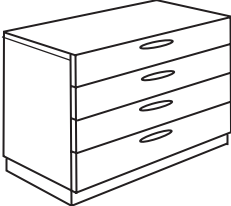
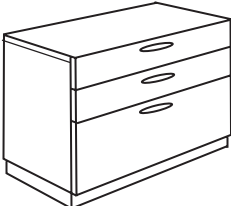
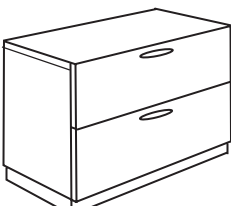
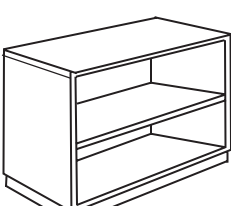
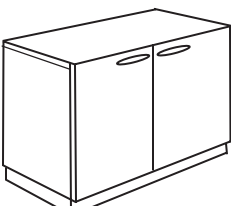
- \* Finished Tops and Mitered Backs
- \* Full Ball-Bearing Progressive Suspension Drawer Slides
- \* Combination Letter/Legal Size Filing
- \* File Drawer Folder Frames

Description	Model	Dimensions			List Prices		Wgt.	Cubes
		D	H	W	Lam/Wood	Wood		
 <p><b>Shelf Cabinet.</b> With one roll out shelf.</p>	<b>E2318N</b>	23	26	18	870	1092	55	7
 <p><b>Single Door Cabinet.</b> With hinged door and one adjustable shelf.</p> <p><b>Same - with lock.</b></p> <p><b>Roll Out Shelf Option</b> (substitute "N" for "M").</p>	<b>E2418MD</b>	23.5	26	18	1206	1430	67	7
	<b>E2418MDL</b>				1299	1520	68	7
	Add				89	89	-	-
 <p><b>Four Box Drawer.</b> Pedestal. With central locking mechanism.</p>	<b>EW36LFL</b>	23.5	26	36	2569	2871	133	13
 <p><b>Two Box and File Drawer Pedestal.</b> With central locking mechanism.</p>	<b>ER36LFL</b>	23.5	26	36	2343	2643	128	13
 <p><b>Two File Drawer Pedestal.</b> With central locking mechanism.</p>	<b>ES36LFL</b>	23.5	26	36	2116	2416	123	13
 <p><b>Open Shelf Cabinet.</b> With 1 roll out shelf.</p>	<b>E3624N</b>	23	26	36	1438	1745	93	13
 <p><b>Double Door Cabinet.</b> With two hinged doors and one adjustable shelf.</p> <p><b>Same - with lock.</b></p> <p><b>Roll Out Shelf Option</b> (substitute "N" for "M").</p>	<b>E3624MD</b>	23.5	26	36	2114	2404	110	13
	<b>E3624MDL</b>	23.5	26	36	2206	2494	110	13
	Add				89	89	-	-

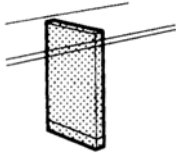
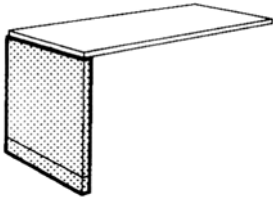
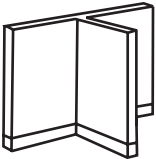
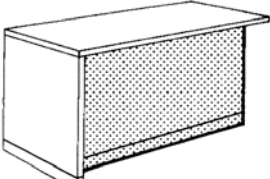

Description	Model	Dimensions	List Prices			
		Size	Lam/Poly U.	Wood	Wgt.	Cubes
 <b>Small Cylinder Base.</b> For capsule and angular shaped tops.	<b>ESB</b>	6" diameter	485	619	13	2.5
	<b>ESBM</b>	6" diameter	228	-	13	2.5
 <b>Half Cylinder Base.</b> Includes anti-tipping weight.	<b>EHB</b>	18" x 10"	930	1083	*30	4.5
*Add 20 lbs. weight for conference table application.						
 <b>Full Cylinder Base.</b> Includes anti-tipping weight.	<b>EFB</b>	18" diameter	1070	1225	*44	8.5
*Add 20 lbs. weight for conference table application.						
 <b>Recessed Leg Support.</b> For use under extended 29"H work surfaces or where heavy support loads demand.	<b>E9A</b>	9" x 27"	172	344	16	1.5
	<b>E15A</b>	15" x 27"	193	383	18	1.7
 <b>Panel Leg Support.</b> For use with 29"H work surface.	<b>E24A</b>	24" x 27"	321	575	22	2.6
	<b>E30A</b>	30" x 27"	375	638	25	3.2
	<b>E36A</b>	36" x 27"	424	701	30	3.8
 <b>T-Shaped Panel Leg.</b> Pedestal Base.	<b>ET24A</b>	24x12x27	513	863	31	6.1
	<b>ET30A</b>	30x12x27	603	953	34	7.5
	<b>ET36A</b>	36x12x27	683	1058	37	9
 <b>Modesty Panel.</b> For use with work surfaces, pedestals and support panels. Finished ends and back. Wood detailed plinth base.	<b>EM30A</b>	30" x 27"	242	325	19	3.2
	<b>EM36A</b>	36" x 27"	280	381	23	3.8
	<b>EM42A</b>	42" x 27"	316	437	27	4.4
	<b>EM48A</b>	48" x 27"	356	493	31	5
	<b>EM60A</b>	60" x 27"	393	550	39	6.2
	<b>EM72A</b>	72" x 27"	431	606	47	7.5

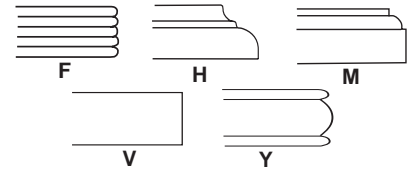
# Executive Suites™

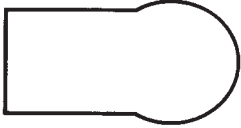
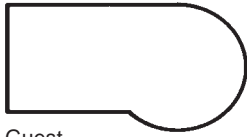
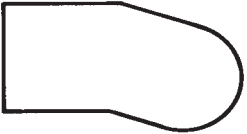

## WORK SURFACES CORNER UNITS

Dimensions

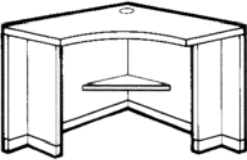
Description	Model	Size	List Prices	Wgt.	Cubes
 <p><b>Capsule Work Surface.</b> 180 degree radiused end in 30" or 36" diameter widths.</p>	6030( )WSB	60" x 30"	1960	69	6.9
	7230( )WSB	72" x 30"	2121	82	8.2
	8430( )WSB	84" x 30"	2697	96	9.6
	9630( )WSB	96" x 30"	3066	110	10.9
	6036( )WSB	60" x 36"	2057	82	8.2
	7236( )WSB	72" x 36"	2229	90	9.8
	8436( )WSB	84" x 36"	2831	99	11.3
	9636( )WSB	96" x 36"	3218	115	12.9
 <p><b>Conference Work Surface.</b> 36" wide tops with 48" diameter conference ends.</p>	7248( )WSC	72" x 36/48"	4269	115	12.8
	8448( )WSC	84" x 36/48"	4558	132	14.9
	9648( )WSC	96" x 36/48"	5275	149	17
	10848( )WSC	108" x 36/48"	5995	166	19.1
 <p><b>P Shaped Work Surface.</b> 36" wide tops with 42" or 48" diameter P shaped end on right. <b>*Note:</b> For curve on left, substitute letter suffix "L" for "R".</p>	7242( )WSPR	72" x 36/42"	3659	96	11.3
	8442( )WSPR	84" x 36/42"	3902	110	13.1
	9642( )WSPR	96" x 36/42"	4519	124	15
	10842( )WSPR	108" x 36/42"	5138	138	16.8
	7248( )WSPR	72" x 36/48"	4269	115	12.8
	8448( )WSPR	84" x 36/48"	4558	132	14.9
	9648( )WSPR	96" x 36/48"	5275	149	17
	10848( )WSPR	108" x 36/48"	5995	166	19.1
 <p><b>Angular Capsule Work Surface.</b> 36" and 42" wide tops with angled 180 degree radius on right. <b>*Note:</b> For curve on left, substitute letter suffix "L" for "R".</p>	8436( )WSAR	84" x 36"	4394	99	14.9
	9636( )WSAR	96" x 36"	5011	115	17
	10836( )WSAR	108" x 36"	5629	132	19.1
	8442( )WSAR	84" x 42"	5123	110	16.7
	9642( )WSAR	96" x 42"	5841	124	19.1
	10842( )WSAR	108" x 42"	6564	138	21.4
 <p><b>Flush Surface Fit Detail.</b> Recommended when butting "M" and "H" edge detail.</p>	<b>Add suffix "FL" to model number.</b>		176	-	-
 <p><b>Free Standing Corner.</b> Unit with riser and power sleeve grommet. Accepts 24" wide returns. Wood veneer cabinetry.</p>	E3636CF-24U	36" x 36" x 29" (24)	2697	98	26
	E4242CF-24U	42" x 42" x 29" (24)	3022	113	35
<b>Note:</b> 42" x 42" cabinets can accommodate keyboard trays, AKs, etc.					
<p><b>Same - laminate cabinetry.</b></p>	E3636CF-24Z	36" x 36" x 29" (24)	1999	98	26
	E4242CF-24Z	42" x 42" x 29" (24)	2321	113	35

Available in a choice of edge detail options. Select edge detail and insert its identification letter ("E" or "M", etc.) in the parenthesis of the top's model suffix number.

# Executive Suites™

## WORK SURFACES

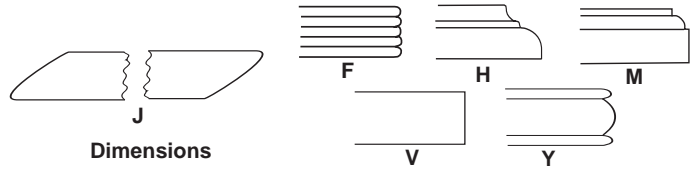

Dimensions

Description	Model	Size	List Prices	Wgt.	Cubes
Rectangular Work Surface. 24" deep.	3624( )WS	36" x 24"	702	36	3.4
	4224( )WS	42" x 24"	757	42	4.0
	4824( )WS	48" x 24"	863	46	4.5
	6024( )WS	60" x 24"	952	61	5.0
	6624( )WS	66" x 24"	1009	66	5.6
	7224( )WS	72" x 24"	1059	73	6.7
	8424( )WS	84" x 24"	1191	85	7.7
	9624( )WS	96" x 24"	1301	97	8.8
	10824( )WS	108" x 24"	1455	109	9.9
	12024( )WS	120" x 24"	1798	152	11
Rectangular Work Surface. 30" deep.	13224( )WS	132" x 24"	2092	168	12.1
	14424( )WS	144" x 24"	2539	183	13.2
	3630( )WS	36" x 30"	891	46	4.2
	4230( )WS	42" x 30"	973	54	4.9
	4830( )WS	48" x 30"	1070	60	5.5
	6030( )WS	60" x 30"	1226	76	6.9
	6630( )WS	66" x 30"	1322	87	7.5
	7230( )WS	72" x 30"	1398	90	8.2
	8430( )WS	84" x 30"	1581	105	9.6
	9630( )WS	96" x 30"	1763	121	10.9
10830( )WS	108" x 30"	1963	136	12.2	
Rectangular Work Surface. 36" deep.	3636( )WS	36" x 36"	1027	54	5.0
	4236( )WS	42" x 36"	1080	63	5.8
	4836( )WS	48" x 36"	1184	73	6.6
	6036( )WS	60" x 36"	1377	90	8.2
	6636( )WS	66" x 36"	1502	99	9.0
	7236( )WS	72" x 36"	1591	109	9.8
	8436( )WS	84" x 36"	1925	124	11.3
	9636( )WS	96" x 36"	2219	142	12.9
	10836( )WS	108" x 36"	2498	159	14.5
	<b>Flush Surface Fit Detail.</b> Recommended when butting either "J", "H" or "M" edge details.	<b>Add suffix "FL" to Model number.</b>		176	-

For interim sizes use next larger size price. Available in a choice of edge detail options. Select edge detail and insert its identification letter ("E" or "M", etc.) in the parenthesis of the top's model suffix number. Secondary work surfaces (24" deep) are detailed on the user side only. Sides and back are square edged to provide a flush fit with adjacent pieces.

# Executive Suites™

## ANGLED WORK SURFACES

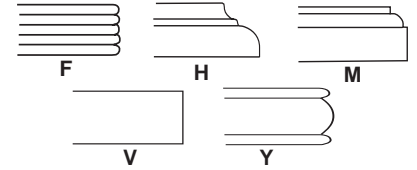

Dimensions

Description	Model	Size	List Prices	Wgt.	Cubes
<b>Angled Computer Surface.</b> Permits accessing computer while facing client.	7236( )WSEL	72" x 36"	2230	86	6.0
	8436( )WSEL	84" x 36"	2598	95	7.0
	9636( )WSEL	96" x 36"	3059	111	7.7
<i>Note: For computer on right, substitute letter suffix "R" for "L".</i>					
<b>Angled Computer Wing Surface.</b> Maximizes surface area for corner or return configurations.	3624( )WSRL	36" x 24"	1047	25	2.3
	4224( )WSRL	42" x 24"	1102	30	2.7
	4824( )WSRL	48" x 24"	1156	35	3.0
	6024( )WSRL	60" x 24"	1389	52	3.7
<i>Note: For computer on right, substitute letter suffix "R" for "L".</i>					
<b>Corner Work Surface.</b> Provides one piece angled corner unit and wing for less obstructed and more usable surface.	7236( )WSL24	72" x 36" x 24"	1996	87	6.0
	8436( )WSL24	84" x 36" x 24"	2173	97	7.0
	9636( )WSL24	96" x 36" x 24"	2306	113	7.7
	7242( )WSL30	72" x 42" x 30"	2554	105	7.2
	8442( )WSL30	84" x 42" x 30"	2779	117	8.8
	9642( )WSL30	96" x 42" x 30"	2951	137	9.9
<i>Note: For computer on right, substitute letter suffix "R" for "L".</i>					
<b>Angled Capsule Work Surface.</b> Permits accessing computer while facing client.	8436( )WSEBL	84" x 36"	3933	95	11.3
	9636( )WSEBL	96" x 36"	4324	111	12.9
<i>Note: For computer on right, substitute letter suffix "R" for "L".</i>					
<b>Flush Surface Fit Detail.</b> Recommended when butting either "J", "H" or "M" edge details.	<b>Add suffix "FL" to model number.</b>		176	-	-



Available in a choice of edge detail options. E surfaces have matching laminate edge banding on all sides (allowing top to be reconfigured). All other surfaces are square edged on non-exposed edges for flush fit. All necessary attachment hardware is included.

Available in a choice of edge detail options. Select edge detail and insert its identification letter ("E" or "M", etc.) in the parenthesis of the top's model suffix number.

# Executive Suites™

## BOW and WEDGE SHAPED SURFACES

Wood tops are 1.5" and glass tops are .75" thick.

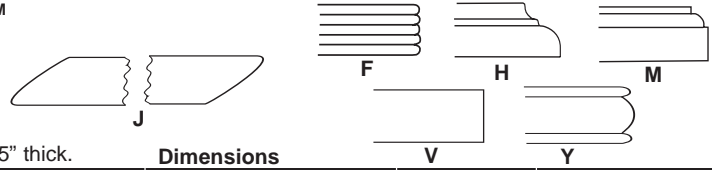

Description	Model	Dimensions		List Prices	Wgt.	Cubes
		Width	Depth			
<b>Wedge Shaped Credenza Work Surface.</b> 24" Deep.	7224( )WSW	72	24	1167	69	6.7
	8424( )WSW	84	24	1309	79	7.8
	9624( )WSW	96	24	1432	91	8.8
	10824( )WSW	108	24	1600	102	9.2
	12624( )WSW	126	24	2220	119	11.5
<b>Wedge Shaped Desk Work Surface.</b> 48" Deep Arched Front.	8448( )WSW	84	39/48	2918	130	14.9
<b>Wedge Shaped Plate Glass Work Surface.</b> 48" Deep Arched Front. Beveled Edges with Special Tapered Elbow Rest.	8448GWSW	84	39/48	4065	204	14.9
<b>Wedge shaped Desk Return Work Surface.</b> For "L" shaped configurations with glass or wedge shaped desk top.	E48466L	102	24	1509	101	8.9
	E48472L	108	24	1600	107	9.2
	E48478L	114	24	1657	113	10.5
	E48484L	120	24	1733	119	11.4
				Actual Return Length		
<b>Wedge Shaped Arched Bridge Work Surface.</b> For "U" configurations with wedge shaped desk and credenza work surfaces. For right return instead of left, substitute "R" for "L" in model #.	4584( )WSL	45/84	16/38	1483	85	9.0
	5187( )WSL	51/87	16/38	1628	92	9.8
<b>Bow Shaped Desk Work Surface.</b> 42" Deep Arched Front with 36" Deep Ends.	7242( )WSA	72	36/42	2116	116	11.3
	7842( )WSA	78	36/42	2314	125	12.2
	8442( )WSA	84	36/42	2494	134	13.1
<b>Bow Shaped Glass Work Surface.</b> 42" Deep Arched Front with 36" Deep Ends.	7242GWSA	72	36/42	3261	181	11.3
	7842GWSA	78	36/42	3460	195	12.2
	8442GWSA	84	36/42	3643	210	13.1

Select edge detail and insert its identification letter within the parenthesis of the surface's model number. For Inlaid leather and decorative veneer tops see page 21. Prices include wood riser supports for use on EOC pedestals and cabinets.

# Executive Suites™

## STACK-ON CABINETS

These cabinets are designed to stack on work surfaces and provide overhead storage. They are also engineered to accept adjacent overhead storage concealed attachments.

### CABINET PRICES INCLUDE:

- \* Fully Adjustable Spring Latched Door Units
- \* Wire Management Provisions
- \* Finished Tops, Backs and Cabinet Interiors
- \* Surface Risers.
- \* Grid Glass Standard. Clear Optional.

### Dimensions

### List Prices

Description	Model	D	H	W	Lam/Wood	Wood	Wgt.	Cubes
<b>Open Shelf Stack-On Cabinet.</b> With 3 adjustable and 1 fixed shelf.	<b>E1848MO</b>	15	49	18	1195	1546	77	11
<b>Swing Door Stack-On Cabinet.</b> With 1 fixed and 3 adjustable shelves.	<b>E1848MDO</b>	16	49	18	1766	2119	94	12
<b>Same - with lock.</b>	<b>E1848MDOL</b>				1862	2213	95	12
<b>Polished Glass Swing Door Showcase.</b> With 1 fixed and 3 adjustable shelves.	<b>E1848MGOD</b>	16	49	18	2410	2777	89	12
<b>Same - with lock.</b>	<b>E1848MGODL</b>				2512	2882	90	12
<b>Recessed Halogen Lamp - installed.</b>	<b>-1HL</b>				295	295	3	-
<b>Open Shelf 36"W Stack-On Cabinet.</b> With 3 adjustable and 1 fixed shelf.	<b>E3648MO</b>	15	49	36	1417	1766	107	21
<b>Double Swing Door Stack-On Cabinet.</b> With 3 adjustable and 1 fixed shelf.	<b>E3648MDO</b>	16	49	36	2472	2890	135	22
<b>Same - with lock.</b>	<b>E3648MDOL</b>				2569	2918	136	22
<b>Double Glass Swing Door Showcase.</b> With 1 fixed and 3 adjustable shelves.	<b>E3648MGOD</b>	16	49	36	3708	4077	127	22
<b>Same - with lock.</b>	<b>E3648MGODL</b>				3809	4175	128	22
<b>Recessed Dbl. Halogen Lamps - installed.</b>	<b>-2HL</b>				402	402	3	-

**Note:** Single swing doors hinge on right unless specified otherwise. Outside backs are fully finished. **TR Tower Roof Trim** with matching detailed edge. Add \$451 list per cabinet and specify detail.

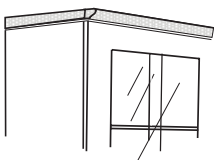
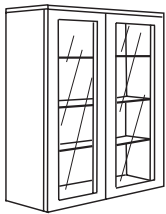
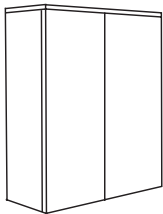
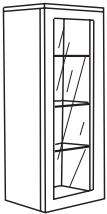
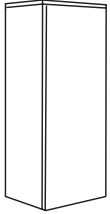
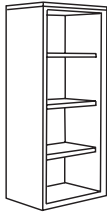

**TR Tower Roof Trim**

# Executive Suites™

## CABINET PRICES INCLUDE:

- \* Glass Showcase Shelves
- \* Fully Adjustable Spring Latched Door Units
- \* Four Shelf Organizer Compartment(s)
- \* Finished Tops, Backs and Cabinet Interiors

## CABINET PRICES INCLUDE:

- \* Fully Adjustable Spring Latched Door Units
- \* Four Shelf Organizer Compartments
- \* Wire Management Provisions
- \* Finished Tops, Backs and Cabinet Interiors
- \* Surface Risers
- \* Grid Glass Standard. Clear Optional

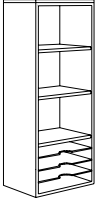
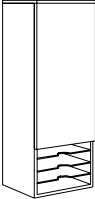
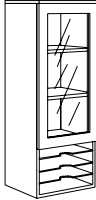
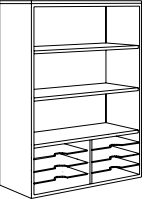
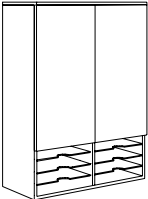
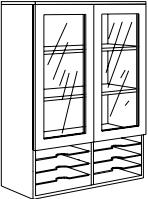
Description	Model	Dimensions			List Prices		Wgt.	Cubes
		D	H	W	Lam/Wood	Wood		
 <b>Open Shelf Stack-On Cabinet.</b> With 3 shelves and 4 shelf organizer.	<b>E1848MSO</b>	15	48	18	1263	1634	79	11
 <b>Swing Door Stack-On Cabinet.</b> With 3 shelves and 4 shelf organizer.	<b>E1848MDSO</b>	16	48	18	1830	2195	94	12
<b>Same - with lock.</b>	<b>EM1848MDSOL</b>				1929	2294	104	12
 <b>Polished Glass Swing Door Showcase.</b> With two adjustable glass shelves, one fixed shelf and 4 shelf organizer.	<b>E1848MGSOD</b>	16	48	18	2487	2866	98	12
<b>Same - with lock.</b>	<b>E1848MGODL</b>				2585	2965	99	12
<b>Recessed Halogen Lamp</b> - installed.	<b>-1HL</b>				295	295	3	-
 <b>Open Shelf 36\"</b>	<b>E3648MSO</b>	15	48	36	1697	2116	111	21
 <b>Double Swing Door Stack-On Cabinet.</b> With three shelves and two 4 shelf organizers.	<b>E3648MDSO</b>	16	48	36	2684	3064	135	22
<b>Same - with lock.</b>	<b>E3648MDSOL</b>				2783	3162	136	22
 <b>Double Glass Swing Door Showcase.</b> With two adjustable glass shelves, one fixed shelf and two 4 shelf organizers.	<b>E3648MGSOD</b>	16	48	36	3933	4326	139	22
<b>Same - with lock.</b>	<b>E3648MGSODL</b>				4032	4424	128	22
<b>Recessed Dbl. Halogen Lamps</b> - installed.	<b>-2HL</b>				402	402	3	-

**Note:** Single swing doors hinge on right unless specified otherwise.

**TR Tower Roof Trim** with matching detailed edge. Add \$451 list per cabinet and specify detail.

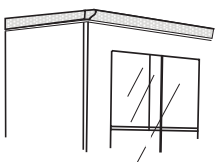

**TR Tower Roof Trim**

# Executive Suites™ OVERHEAD STORAGE UNITS

Can be suspended from adjacent cabinets or wall hung.

## CABINET PRICES INCLUDE:

- \* Task Lamp Valance Shields
- \* Fully Adjustable Hinges
- \* Finished Tops and Cabinet Interiors
- \* Fully Enclosed Back
- \* Adjacent Cabinet Attachment Brackets

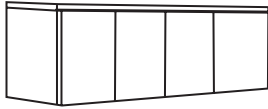
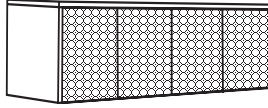
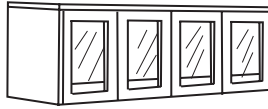
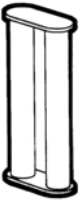
Description	Model	Dimensions			List Prices			
		D	H	W	Lam/Wood	Wood	Wgt.	Cubes
<b>Corner Open Shelf Unit.</b> With enclosed top.  <i>*Requires corner stanchion support when suspended.</i>	<b>E36COS</b>	15	17	36	1454	1929	93	17
								
<b>Swing Door Unit.</b> 13-3/4" inside depth.	<b>E36MD</b>	16	17	36	1052	1510	62	8
	<b>E54MD</b>	16	17	54	1426	1916	93	13
	<b>E72MD</b>	16	17	72	1659	2216	125	15
	<b>E90MD</b>	16	17	90	1937	2504	155	18
	<b>E108MD</b>	16	17	108	2191	2805	186	22
								
<b>Decorative Metal Swing Door Unit.</b> Debossed metal faced overhead swing doors	<b>E36MMD</b>	16	17	36	1217	1637	62	8
	<b>E54MMD</b>	16	17	54	1687	2136	93	13
	<b>E72MMD</b>	16	17	72	2027	2537	125	15
	<b>E90MMD</b>	16	17	90	2281	2928	155	18
	<b>E108MMD</b>	16	17	108	2766	3329	186	22
								
<b>Glass Swing Door Unit.</b> 13-3/4" inside depth.	<b>E36MG</b>	16	17	36	1624	2081	57	8
	<b>E54MG</b>	16	17	54	2285	2785	86	13
	<b>E72MG</b>	16	17	72	2803	3361	115	15
	<b>E90MG</b>	16	17	90	3206	3934	144	18
	<b>E108MG</b>	16	17	108	3908	4521	173	22
 <p><i>See page 13 for lighting accessories.</i></p>								
<b>Stanchion Supports.</b> For support of overhead units above work surfaces.					Polyurethane 496	Wood 575	8	6
<b>Double</b>	<b>E312S</b>	34						
								

**TR Tower Roof Trim** with matching detailed edge. Add \$451 list per cabinet and specify detail.

**Note:** For wall mounting brackets add "Z" to model number and \$35 list.

### Wall Mounting Information:

Wall mounted cabinets include separate cleats for the wall but do not include wall attachment hardware. It is the responsibility of the installer to use the correct hardware, based on the wall type, construction, etc. (see "Wall Mounted Cabinets" on page 7.)

### Clearance Dimensions:

Shelf height = 12"

Shelf Depth = 13.5"



Clearance between worksurface and double overhead cabinets on 78" high system = 31"

**Lighting, Tack Panels and Organizers - See Accessories.**

# Executive Suites™ STORAGE CABINETS - 24" DEPTH

## CABINET PRICES INCLUDE:

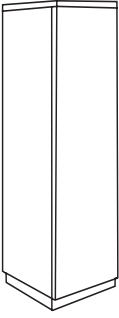
- \* Fully Adjustable Hinges and Spring Latches
- \* Wire Management and Ganging Provisions
- \* Full Ball-Bearing Progressive Suspension Drawer Slides
- \* Adjustable (1" increments) Shelves

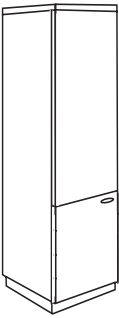
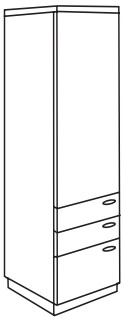
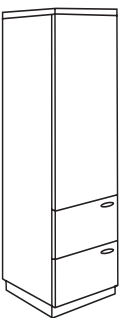
Description	Model	Dimensions			List Prices				
		D	H	W	Lam/Wood	Wood	Wgt.	Cubes	
 <b>Swing Door Cabinet.</b> 3 adjustable and 2 fixed shelves.	<b>E1877MD</b>	24	78	18	3059	3606	145	24	
	<b>Same - with door lock.</b>	<b>E1877MDL</b>	24	78	18	3153	3698	146	24
 <b>Wardrobe Cabinet.</b> Storage shelf and hanger rail.	<b>E1877CD</b>	24	78	18	2871	3384	125	24	
	<b>Same - with door lock.</b>	<b>E-1877CDL</b>	24	78	18	2964	3478	126	24
	<b>Door Mirror (inside).</b>	<b>-M</b>				295	295	6	-
 <b>Combination Storage Unit.</b> 2 Swing doors with 2 fixed and 4 adjustable shelves.	<b>E1877MDD</b>	24	78	18	2796	3303	133	24	
	<b>Same - with door lock.</b>	<b>E1877MDDL</b>	24	78	18	2900	3406	134	24
 <b>Combination Storage Unit.</b> Swing door with 3 adjustable and 1 fixed shelf. 2 box and 1 file drawer with locking system.	<b>E1877MDR</b>	24	78	18	3872	4565	178	24	
	<b>Same - with door lock.</b>	<b>E1877MDRL</b>	24	78	18	3976	4669	179	24
 <b>Combination Storage Unit.</b> Swing door with 3 adjustable and 1 fixed shelf. 2 file drawers with locking system.	<b>E1877MDS</b>	24	78	18	3872	4565	177	24	
	<b>Same - with door lock.</b>	<b>E1877MDSL</b>	24	78	18	3976	4667	178	24

Optional -M Door Mirror

**TR Tower Roof Trim** with matching detailed edge. Add \$451 list per cabinet and specify detail.

# Executive Suites™

## STORAGE and SHOWCASE CABINETS - 24" DEPTH

### CABINET PRICES INCLUDE:

- \* Fully Adjustable Hinges and Spring Latches
- \* Wire Management and Ganging Provisions
- \* Full Ball-Bearing Progressive Suspension Drawer Slides
- \* Adjustable (1" increments) Shelves
- \* Grid Glass Standard. Clear Optional

Dimensions List Prices

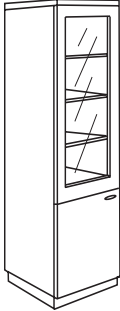
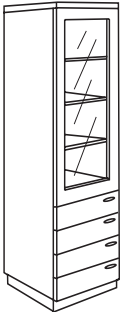
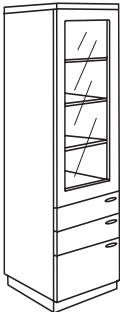
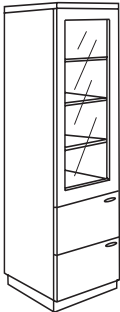
Description	Model	Dimensions			List Prices				
		D	H	W	Lam/Wood	Wood	Wgt.	Cubes	
 <b>Glass Door Showcase.</b> With single door storage below. 2 fixed and 4 adjustable shelves.	<b>E1877MGD</b>	24	78	18	3954	4677	139	24	
	<b>Same - with door lock.</b>	<b>E1877MGDL</b>	24	78	18	4045	4752	140	24
	<b>Recessed Halogen Lamp - installed.</b>	<b>-1HL</b>				295	295	3	-
 <b>Glass Door Showcase.</b> With 4 box drawers below with locking system. 1 fixed and 3 adjustable shelves.	<b>E1877MGW</b>	24	78	18	4950	5827	177	24	
	<b>Same - with door lock.</b>	<b>E1877MGWL</b>	24	78	18	5051	5933	178	24
	<b>Recessed Halogen Lamp - installed.</b>	<b>-1HL</b>				295	295	3	-
 <b>Glass Door Showcase.</b> With 2 box/1file drawer below with locking system. 1 fixed and 3 adjustable shelves.	<b>E1877MGR</b>	24	78	18	4950	5827	172	24	
	<b>Same - with door lock.</b>	<b>E1877MGRL</b>	24	78	18	5051	5933	173	24
	<b>Recessed Halogen Lamp - installed.</b>	<b>-1HL</b>				295	295	3	-
 <b>Glass Door Showcase.</b> With 2 file drawers below with locking system. 1 fixed and 3 adjustable shelves.	<b>E1877MGS</b>	24	78	18	4950	5827	171	24	
	<b>Same - with door lock.</b>	<b>E1877MGSL</b>	24	78	18	5051	5933	172	24
	<b>Recessed Halogen Lamp - installed.</b>	<b>-1HL</b>				295	295	3	-

TR Tower Roof Trim with matching detailed edge. Add \$451 list per cabinet and specify detail.

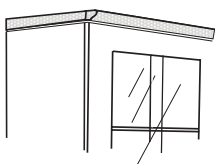

TR Tower Roof Trim

# Executive Suites™

## CABINET PRICES INCLUDE:

- \* Fully Adjustable Hinges and Spring Latches
- \* Wire Management and Ganging Provisions
- \* Full Ball-Bearing Progressive Suspension Drawer Slides
- \* Adjustable (1" increments) Shelves

## STORAGE AND WARDROBE CABINETS - 24" DEPTH

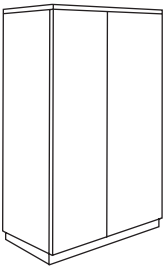
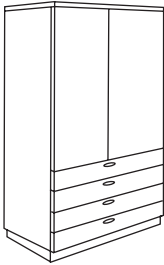
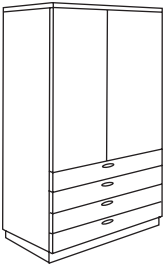
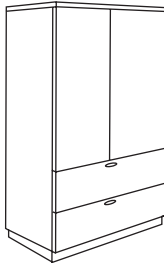
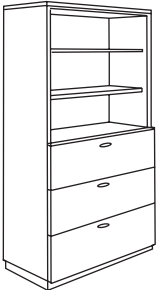
Description	Model	Dimensions			List Prices				
		D	H	W	Lam/Wood	Wood	Wgt.	Cubes	
 <p><b>Storage/Wardrobe Cabinet.</b> 4 adjustable and 2 fixed shelves on left. Hanger rail and storage shelf on right.</p>	<b>E3677CD</b>	24	78	36	4543	5349	245	45	
	<b>Same - with door lock.</b>	<b>E3677CDL</b>	24	78	36	4636	5440	246	45
	<b>Door mirror (inside).</b>	<b>-M</b>				295	295	6	-
 <p><b>Storage/Wardrobe Cabinet.</b> 3 adjustable and 1 fixed shelf on left. Hanger rail on right. 4 box drawers below.</p>	<b>E3677CDW</b>	24	78	36	4279	5033	207	45	
	<b>Same - with door lock.</b>	<b>E3677CDWL</b>	24	78	36	4370	5124	208	45
 <p><b>Double Door Cabinet.</b> With double swing doors and 4 convenience drawers below with central locking system. Includes 3 adjustable and 1 fixed shelf.</p>	<b>E3677MDW</b>	24	78	36	4777	5979	257	45	
	<b>Same - with door lock.</b>	<b>E3677MDWL</b>	24	78	36	4870	6072	258	45
 <p><b>Double Door Cabinet.</b> With double swing doors and 2 lateral file drawers with central locking system. Includes 3 adjustable and 1 fixed shelf.</p>	<b>E-3677MDS</b>	24	78	36	4682	5496	244	45	
	<b>Same - with door lock.</b>	<b>E3677MDSL</b>	24	78	36	4774	5588	245	45
 <p><b>Open Shelf Cabinet.</b> 3 drawer lateral file with central locking system. 2 adjustable and 1 fixed shelf.</p>	<b>E3677MOY</b>	24	78	36	4533	5310	257	45	
	<b>Same - with bookcase swing doors and locks.</b>	<b>E3677MDYL</b>	24	78	36	5198	6090	275	45

**TR Tower Roof Trim** with matching detailed edge. Add \$451 list per cabinet and specify detail.

**Note:** Tops and outside backs are fully finished.

Two box drawers may be substituted for file drawer and vice versa.

# Executive Suites™

## STORAGE and SHOWCASE CABINETS - 24" DEPTH

### CABINET PRICES INCLUDE:

- \* Fully Adjustable Hinges and Spring Latches
- \* Wire Management and Ganging Provisions
- \* Full Ball-Bearing Progressive Suspension Drawer Slides
- \* Adjustable (1" increments) Shelves
- \* Grid Glass Standard. Clear Optional

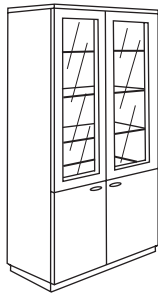

Description	Model	Dimensions			List Prices			
		D	H	W	Lam/Wood	Wood	Wgt.	Cubes
<b>Glass Door Showcase.</b> With double door storage below. 2 fixed and 4 adjustable shelves.	<b>E3677MGD</b>	24	78	36	6503	7639	225	45
<b>Same - with locks.</b>	<b>E3677MGDL</b>	24	78	36	6601	7752	226	45
<b>Recessed Double Halogen Lamps</b> - installed.	<b>-2HL</b>				402	402	3	-

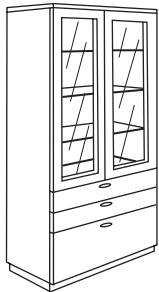

<b>Glass Door Showcase.</b> With 2 convenience drawers, lateral file drawer and central locking system. 1 fixed and 3 adjustable shelves.	<b>E3677MGR</b>	24	78	36	6805	7994	264	45
<b>Same - with lock.</b>	<b>E3677MGRL</b>	24	78	36	6901	8092	265	45
<b>Recessed Double Halogen Lamps</b> - installed.	<b>-2HL</b>				402	402	3	-

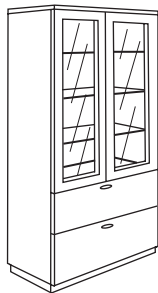

<b>Glass Door Showcase.</b> With 2 lateral file drawers with central locking system. 1 fixed and 3 adjustable shelves.	<b>E3677MGS</b>	24	78	36	6512	7650	250	45
<b>Same - with showcase door locks.</b>	<b>E3677MGSL</b>	24	78	36	6609	7749	251	45
<b>Recessed Double Halogen Lamps</b> - installed.	<b>-2HL</b>				402	402	3	-

**TR Tower Roof Trim** with matching detailed edge. Add \$451 list per cabinet and specify detail.

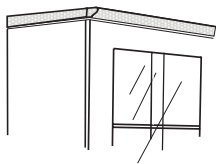

**TR Tower Roof Trim**

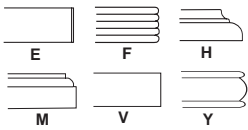

Hardwood Edge Detail Options  
(Insert letter in model number parenthesis)

# Executive Suites™ MODULAR BOOKCASES

**CABINET PRICES INCLUDE:**

- \* 1-5/8" Thick Hardwood Edge Top (Specify Detail)
- \* Adjustable Shelves that are Finished on Both Sides
- \* Fully Finished Interiors and Exteriors

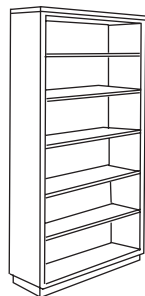
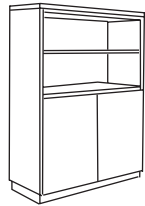
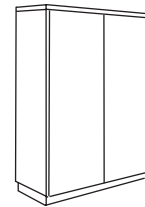
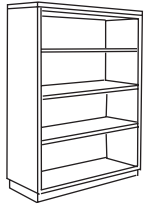
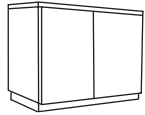
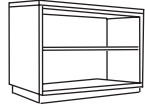

Description	Model	Dimensions			List Prices		Wgt.	Cubes
		D	H	W	Lam/Wood	Wood		
Bookcase. 2 shelves (1 adjustable).	E( )3029B	13	29	30	798	939	51	9
	E( )3629B	13	29	36	870	1021	56	10
Bookcase. 2 shelves (1 adjustable) with adjustable swing doors.	E( )3029BD	14	29	30	947	1114	63	10
	E( )3629BD	14	29	36	1028	1211	71	11
Door Lock.	add -L				88	88	1	0
Bookcase. 4 shelves (3 adjustable).	E( )3053B	13	54	30	1203	1415	88	16
	E( )3653B	13	54	36	1307	1538	103	18
Bookcase. 4 shelves (3 adjustable) with full height swing doors.	E( )3053BD	14	54	30	1425	1677	107	17
	E( )3653BD	14	54	36	1548	1822	119	19
Door Lock.	add -L				88	88	1	0
Bookcase. 4 shelves (2 adjustable) with lower swing door cabinet.	E( )3053BHD	14	54	30	1351	1590	99	17
	E( )3653BHD	14	54	36	1469	1729	111	19
Door Lock.	add -L				88	88	1	0
Bookcase. 6 shelves (4 adjustable).	E( )3072B	13	72	30	1469	1741	104	21
	E( )3672B	13	72	36	1610	1894	116	25
Extra Shelf.	E30S	12	0.8	28	108	129	3	0.8
	E36S	12	0.8	34	117	138	4	0.9

**Heavy Duty Shelf Option:** To substitute 1-1/4" thick for standard 3/4" thick bookcase shelves, add suffix "-HD" to model number and \$23.00 list per shelf.

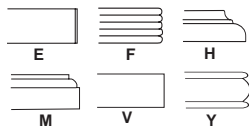

Hardwood Edge Detail Options  
(Insert letter in model number parenthesis)

# Executive Suites™

## LATERAL FILES

**CABINET PRICES INCLUDE:**

- \* 1-5/8" Thick Hardwood Edge Top (Specify Detail)
- \* Fully Finished Top, Sides and Back
- \* Ball Bearing Full Suspension Slides
- \* Anti-tip Locking System
- \* Letter/Legal Size Drawer Folder Frames
- \* Maple Grained Drawer Interiors

Description	Model	Dimensions			List Prices			
		D	H	W	Lam/Wood	Wood	Wgt.	Cubes
<b>Two Drawer File.</b> Anti-tip locking system. Front to back and cross filing.	E( )S30LFRL	19	29	30	1581	1862	124	11
	E( )S36LFRL	19	29	36	1738	2046	128	13
<b>Three Drawer File.</b> Anti-tip locking system. Front to back and cross filing.	E( )Y30LFRL	19	42	30	2487	2924	150	17
	E( )Y36LFRL	19	42	36	2602	3060	176	20
<b>Four Drawer File.</b> Anti-tip locking system. Front to back and cross filing.	E( )M30LFRL	19	54	30	2949	3469	196	22
	E( )M36LFRL	19	54	36	3131	3683	233	26
<b>Two 6"H Storage Drawers.</b> Substituted for one 12" high file drawer. Specify location. Factory installed only.	Add -R	16	6	30	210	210	4	-
	Add -R	16	6	36	217	217	5	-

